

## 15 Watt DC-DC Converters

## IMS 15 Series

**Input to output electric strength test 1500 V DC**  
**Input voltage ranges: 14...36 and 36...75 V DC**  
**Single, dual and double outputs**  
**Configurable output voltages from 3.3 to 48 V DC**

- Electrical isolation, also between outputs
- Emissions below EN 55022, level B
- Immunity to IEC/EN 61000-4-2,-3,-4,-5 and -6
- High efficiency (typ. 86%)
- Input undervoltage lock-out
- Shut down input, output voltages adjustable
- Flex power: Flexible load distribution on outputs
- Outputs no-load, overload and short-circuit proof
- Operating ambient temperature –25...71 °C
- Thermal protection
- 2" × 1.6" case with 10.5 mm profile
- Supplementary insulation

Safety according to IEC/EN 60950, UL 1950



Approvals pending

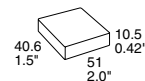

### Summary

The IMS 15 series of board mountable 15 Watt DC-DC converters has been designed according to the latest industry requirements and standards. The converters are particularly suitable for applications in industry and telecommunications where variable input voltages or high transient voltages are prevalent.

Providing two wide input voltage ranges, 14...36 V DC and 36...75 V DC, the units are available with single, dual and electrically isolated double outputs allowing the configuration of output voltages from 3.3 up to 48 V DC externally adjustable, with flexible load distribution on dual and double output units. A shut down input allows remote converter on/off. Features include efficient input and output filtering with unsurpassed transient and surge protection, low output ripple and noise, consistently high efficiency over the entire input voltage range, high reliability as well as excellent dynamic response to load and line changes.

The converters provide supplementary insulation with SELV outputs as e.g. required in battery supported systems where the bus voltage may exceed the SELV limit of 60 V DC. They are designed and built according to the international safety standards IEC/EN 60950, UL 1950, CAN/CSA C22.2 No.950-95. Approvals pending.

The circuit comprises of integrated planar magnetics and all components are automatically assembled and solidly soldered onto a single PCB without any wire connections. The proprietary magnetic feedback solution ensures maximum reliability and repeatability in the control loop over all operating conditions. Careful considerations of possible thermal stresses ensure the absence of hot spots providing long life in environments where temperature cycles are a reality. The thermal design allows operation at full load up to an ambient temperature of 71 °C in free air without using any potting material. An extended temperature range –40...71 °C is available as an option. For extremely high vibration environments the case has holes for screw mounting.

### Table of Contents

	Page		Page
Summary .....	1	Auxilliary Functions .....	8
Type Survey and Key Data .....	2	Electromagnetic Compatibility (EMC) .....	9
Type Key and Product Marking .....	2	Immunity to Environmental Conditions .....	10
Functional Description .....	3	Mechanical Data .....	11
Electrical Input Data .....	4	Safety and Installation Instructions .....	11
Electrical Output Data .....	5	Description of Option .....	13



**MELCHER**  
The Power Partners.

Edition 5/7.99  
1/13

**POWER-ONE**  
GROUP OF COMPANIES

Type Survey and Key Data

Table 1: Type survey

Output 1		Output 2		Output power $P_{o \text{ nom}}$ [W]	Input Voltage Range and Efficiency				Option
$U_{o1 \text{ nom}}$ [V DC]	$I_{o1 \text{ nom}}$ [A]	$U_{o2 \text{ nom}}$ [V DC]	$I_{o2 \text{ nom}}$ [A]		$U_{i \text{ min}} \dots U_{i \text{ max}}$ <b>14...36 V DC</b>	$\eta_{\text{typ}}$ [%]	$U_{i \text{ min}} \dots U_{i \text{ max}}$ <b>36...75 V DC</b>	$\eta_{\text{typ}}$ [%]	
5.1	2.7	-	-	13.8	24 IMS 15-05-7R	84	48 IMS 15-05-7R	83	-9, i
5.1	1.6	3.3	1.6	13.5	24 IMS 15-0503-7R	82	48 IMS 15-0503-7R	82	-9, i
5	1.4	5	1.4	14	24 IMS 15-05-05-7	85	48 IMS 15-05-05-7	83	-9, K <sup>2</sup> , i
12	0.7	12	0.7	16.8	24 IMS 15-12-12-7	88	48 IMS 15-12-12-7	86	-9, K <sup>2</sup> , i
15	0.56	15	0.56	16.8	24 IMS 15-15-15-7	88	48 IMS 15-15-15-7	86	-9, K <sup>2</sup> , i
24	0.35	24	0.35	16.8	24 IMS 15-24-24-7	87	48 IMS 15-24-24-7	86	-9, i

<sup>1</sup> Flexible load distribution on dual and double outputs possible up to 75% of  $P_{o \text{ nom}}$  on one of the 2 outputs, 24/48 IMS 15-0503-7 types allow; 2 A max. on one of the 2 outputs. The other output should not exceed the difference to the total output power  $P_{o \text{ nom}}$ .

<sup>2</sup> Option K: Alternative pinout with common ground (Vo+, Go, Vo-), excludes option i.

Type Key and Product Marking

Type Key

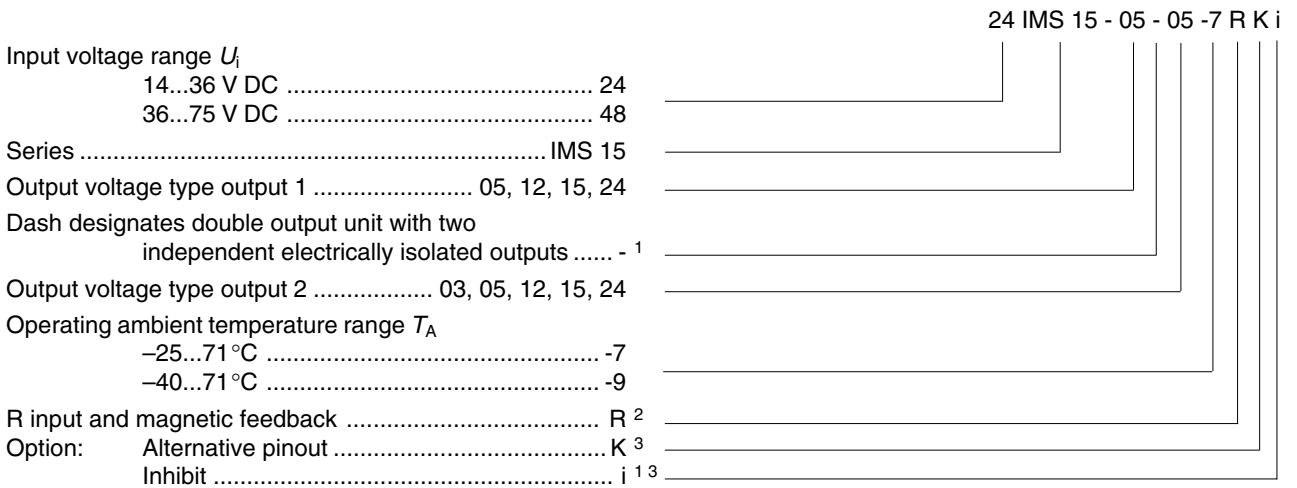

<sup>1</sup> Not applicable with option K

<sup>2</sup> Single output and -0503- types

<sup>3</sup> For delivery lead times contact factory. Requires a minimum order quantity.

Examples: 48 IMS 15-05-05-7: DC-DC converter, input voltage range 36...75 V, 2 electrically isolated outputs each providing 5 V, 1.4 A.

24 IMS 15-0505-7K: DC-DC converter, input voltage range 14...36 V, alternative pinout with outputs ±5 V, ±1.4 A.

Product Marking

Basic type designation, output voltages and currents, applicable safety approval and recognition marks, Melcher patent nos. and company logo. Side label: Date code and serial no.

### Functional Description

The IMS 15 series of DC-DC converters are magnetic feedback controlled flyback converters using current mode PWM (Pulse Width Modulation). The -05- and -0503- output voltage versions feature an active magnetic feedback loop via a pulse transformer which results in very tight regulation of the output voltage (see fig.: *Block diagram, single and -0503- output types*). The output voltages of these versions can be adjusted via the R input. The R input is referenced to the secondary side and allows for programming of the output voltages in the range of approximately 80 to 105% of  $U_{o\ nom}$  using either an external resistor or an external voltage source.

The voltage regulation on the dual and double output versions is achieved with a passive transformer feedback from the main transformer (see fig.: *Block diagram, for double*

*output types*). The output voltages can be adjusted via the Trim input. The Trim input is referenced to the primary side of the converter and allows for programming of the output voltages in the range 100 to 105% of  $U_{o\ nom}$  by an external resistor or within 75 to 105% using an external voltage source. The load regulation output characteristic allows for paralleling of one or several double output units of equal output voltages.

Current limitation is provided by the primary circuit, thus limiting the total output power of double output types to approx. 130% of  $P_{o\ nom}$  (see: *Type Survey*). The shut down input allows remote converter on/off.

Overtemperature protection will shut down the unit in excessive overload conditions with automatic restart approximately every 50 to 60 ms.

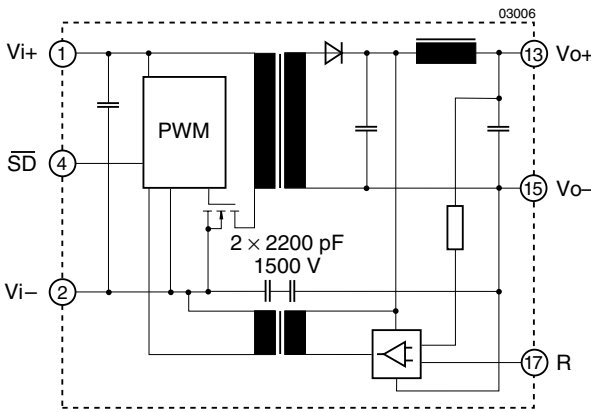

Fig. 1  
Block diagram, single output types.

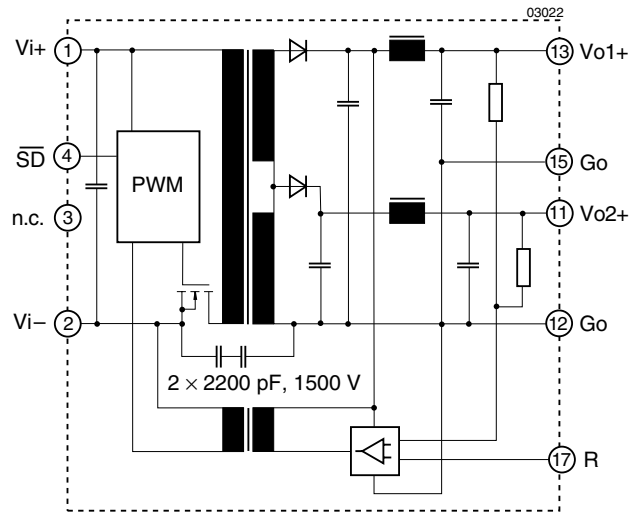

Fig. 2  
Block diagram, -0503- types.

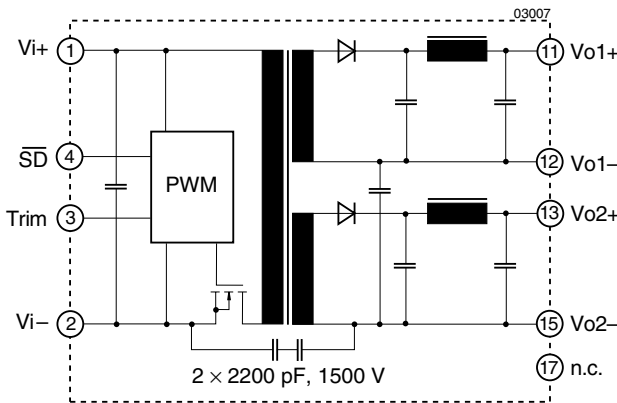

Fig. 3  
Block diagram, double output types, standard pinout.

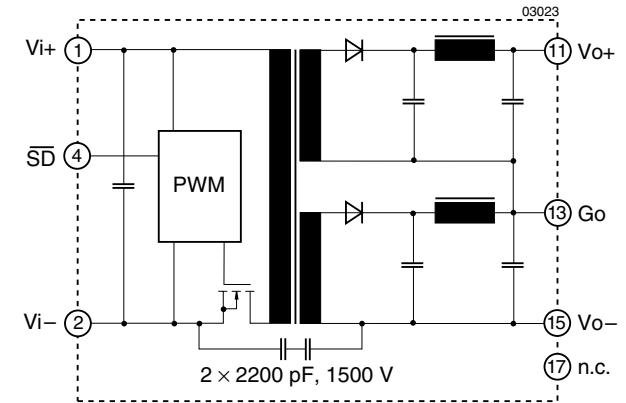

Fig. 4  
Block diagram, dual output types, alternative K-pinout.

### Electrical Input Data

General conditions:

- $T_A = 25^\circ\text{C}$ , unless  $T_C$  is specified.
- Shut down pin left open circuit (not connected).
- Trim or R input not connected.

Table 2: Input Data

Input			24 IMS			48 IMS			Unit
Characteristics		Conditions	min	typ	max	min	typ	max	
$U_i$	Input voltage range <sup>1</sup>		14		36	36		75	V DC
$U_{i\text{ nom}}$	Nominal input voltage		24			48			
$U_{i\text{ sur}}$	Repetitive surge voltage		50			100			
$t_{\text{start up}}$	Converter start-up time	Switch on	0.25		0.5	0.25		0.5	s
		$\overline{\text{SD}}$ high			0.1			0.1	
$t_{\text{rise}}$	Rise time		5			5			ms
$I_o$	No load input current		20		40	10		20	mA
$C_i$	Input capacitance		4.0			2.0			$\mu\text{F}$
$U_{\overline{\text{SD}}}$	Shut down voltage		Unit disabled			-10...0.7			V DC
			Unit operating			2.0...20			
$R_{\overline{\text{SD}}}$	Shut down input resistance		10			10			k $\Omega$
$I_{\overline{\text{SD}}}$	Input current if unit shut down		1.2		3	1.2		3	mA
$I_{\text{inr p}}$	Inrush peak current <sup>4</sup>		5			4.5			A
$f_s$	Switching frequency		approx. 350			approx. 350			kHz
$I_{i\text{ rr}}$	Reflected ripple current		30			30			mA <sub>pp</sub>
$U_{i\text{ RFI}}$	Input RFI level conducted		B			B			

<sup>1</sup>  $U_{i\text{ min}}$  will not be as stated if  $U_o$  is increased above  $U_{o\text{ nom}}$  by use of the R or Trim input. If the output voltage is set to a higher value,  $U_{i\text{ min}}$  will be proportionally increased.

<sup>2</sup> Measured with a resistive and the max. admissible capacitive load.

<sup>3</sup> Measured with a lead length of 0.1 m, leads twisted. Double output units with both outputs in parallel.

<sup>4</sup> Source impedance according to prETS 300132-2, version 4.3.

#### Inrush Current

The inrush current has been kept as low as possible by choosing a very small input capacitance.

A series resistor may be installed in the input line to further limit this current.

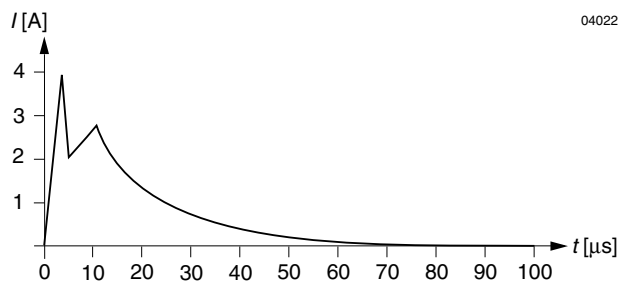

Fig. 5  
Typical inrush current at  $U_{i\text{ nom}}$ ,  $P_{o\text{ nom}}$  versus time (48 IMS 15). Source impedance according to prETS 300132-2, version 4.3 at  $U_{i\text{ nom}}$ .

#### Input Undervoltage Lock-out

The IMS 15 converters are fitted with a defined input undervoltage lock-out (approx. values):

24 IMS 15	turn off	12.5 V
	turn on	13 V
48 IMS 15	turn off	31.5 V
	turn on	32 V

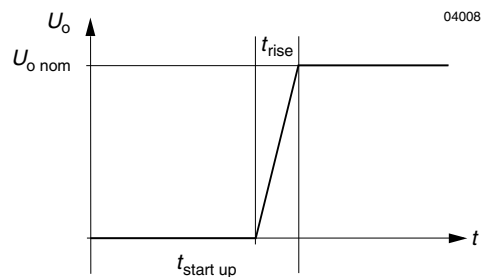

Fig. 6  
Converter start-up and rise time.

**Input Transient Voltage Protection**

A built-in suppressor diode provides effective protection against input transients which may be caused for example by short-circuits accross the input lines where the network inductance may cause high energy pulses.

Table 3: Built-in transient voltage suppressor

Type	Breakdown voltage $V_{BR\ nom}$ [V]	Peak power at 1 ms $P_P$ [W]	Peak pulse current $I_{PP}$ [A]
24 IMS 15	53	600	7.7
48 IMS 15	100	600	4.1

For very high energy transients as for example to achieve IEC/EN 61000-4-5 or ETR 283 (19 Pfl1) compliance (as per table :Electromagnetic Immunity) an external inductor and capacitor are required.

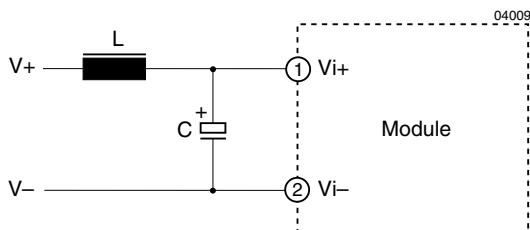

Table 4: Components for external circuitry to comply with IEC/EN 61000-4-5, level 2 or ETR 283 (19Pfl1) (48 IMS types).

Circuit Ref.	24 IMS 15	48 IMS 15
L	150 $\mu$ H, 0.294 $\Omega$ , 640 mA TOKO: 494 LYF-0094K <sup>1</sup>	
C	150 $\mu$ F, 63 V, 85°C	100 $\mu$ F, 150 V, 85°C

<sup>1</sup> Available from TOKO Components Division

**Reverse Polarity Protection at the Input**

The built-in suppressor diode also provides for reverse polarity protection at the input by conducting current in the reverse direction. An external fuse is required to limit this current.

- For 24 IMS 15 types a fast 3.15 A (F3.15A) fuse is recommended.
- For 48 IMS 15 types a fast 2 A (F2A) fuse is recommended.

Fig. 7

Example for external circuitry to comply with IEC/EN 61000-4-5 or ETR 283 (19 Pfl1) (48 IMS15 types).

**Electrical Output Data**

General conditions:

$T_A = 25^\circ\text{C}$ , unless  $T_C$  is specified. Shut down pin left open (not connected). Trim- or R-input not connected.

Table 5a: Output data for single output units and -0503- types.

Output		5.1 V		5.1/3.3 V		Unit		
Characteristics		min	typ max	min	typ max			
$U_{o1}$ $U_{o2}$	Output voltage	$U_{I\ nom}$ $I_o = 0.5 I_o\ nom$		5.05	5.15	5.0	5.12	V
$I_o\ nom$	Output current <sup>1</sup>	$U_{I\ min...U_{I\ max}}$		2.7		2 x 1.6		A
$I_{o1L}$ $I_{o2L}$	Current limit <sup>2,4</sup>	$U_{I\ nom}, T_C = 25^\circ\text{C}$ $U_o = 90\% U_{o\ nom}$		3.5		3.0		3.8
$\Delta U_o$	Line/load regulation	$U_{I\ min...U_{I\ max}, I_o = (0.01...1) I_o\ nom}$		$\pm 1$				%
		$U_{I\ min...U_{I\ max}}$	5.1 V			+3, -5		
		$I_o = (0.1...1) I_o\ nom$	3.3 V			$\pm 4.5$		
$u_{o1/2}$	Output voltage noise	$U_{I\ min...U_{I\ max}}$ $I_o = I_o\ nom$		5	70	80		mV <sub>pp</sub>
				6	40	40		
$U_{oL}$	Output overvoltage limitation			115	130	115	130	%
$C_{o\ ext}$	Admissible capacitive load <sup>3</sup>			4000		total 4000		$\mu$ F
$u_{o\ d}$	Dynamic load regulation	Voltage deviat.	$U_{I\ nom}$	$\pm 250$		$\pm 150$		mV
$t_d$		Recovery time	$I_o\ nom \leftrightarrow 1/2 I_o\ nom$ IEC/EN 61204	1		1		ms
$\alpha_{Uo}$	Temperature coefficient $\Delta U_o/\Delta T_C$	$U_{I\ min...U_{I\ max}}$ $I_o = 0...I_o\ max$		$\pm 0.02$		$\pm 0.02$		%/K

<sup>1</sup> Flexible load distribution: 24/48 IMS 15-0503-7 types; 2 A max. on one of the 2 outputs, the other output should not be loaded such that the total output power exceeds  $P_{o\ nom}$  according to table: Type survey.

<sup>2</sup> The current limit is primary side controlled.

<sup>3</sup> Measured with both outputs connected in parallel. For -0503- types: total capacitance, both outputs.

<sup>4</sup> Conditions for specified output. Other output loaded with constant current  $I_o = 0.5 I_o\ nom$ .

<sup>5</sup> BW = 20 MHz

<sup>6</sup> Measured with a probe according to EN 61204

<sup>7</sup> The overvoltage protection is not tracking with R/Trim control.

Table 5b: Output data for dual and double output units.

Output			2 × 5 V		2 × 12 V		2 × 15 V		2 × 24 V				
Characteristics		Conditions	min	typ	max	min	typ	max	min	typ	max	Unit	
$U_{o1}$ $U_{o2}$	Output voltage	$U_{i\ nom}$ $I_o = 0.5 I_{o\ nom}$	4.92	5.08	11.82	12.18	14.78	15.22	23.64	24.36	23.64	24.36	V
$I_{o\ nom}$	Output current <sup>1</sup>	$U_{i\ min} \dots U_{i\ max}$	2 × 1.4		2 × 0.7		2 × 0.56		2 × 0.35			A	
$I_{oL}$	Current limit <sup>2, 4</sup>	$U_{i\ nom}, T_C = 25^\circ C$ $U_o = 90\% U_{o\ nom}$	3.5		1.9		1.6		0.95				
$\Delta U_{oU}$	Line regulation	$U_{i\ min} \dots U_{i\ max}, I_{o\ nom}$	±1		±1		±1		±1			%	
$\Delta U_{oI}$	Load regulation	$U_{i\ nom}$ $I_o = (0.1 \dots 1) I_{o\ nom}$	±3		±3		±3		±3				
$u_{o1/2}$	Output voltage noise	$U_{i\ min} \dots U_{i\ max}$ <sup>5</sup> $I_o = I_{o\ nom}$ <sup>6</sup>	80		120		150		240			mV <sub>pp</sub>	
$U_{oL}$	Output overvoltage limit. <sup>7</sup>	Min. load 1%	115	130	115	130	115	130	115	130		%	
$C_{o\ ext}$	Admissible capacitive load <sup>3</sup>		4000		620		470		180			µF	
$u_{o\ d}$	Dynamic load regulation	Voltage deviat. Recovery time	$U_{i\ nom}$		±250		±600		±750		±900		mV
$t_d$			$I_{o\ nom} \leftrightarrow 1/2 I_{o\ nom}$		1		1		1		1		ms
$\alpha_{Uo}$	Temperature coefficient $\Delta U_o / \Delta T_C$	$U_{i\ min} \dots U_{i\ max}$ $I_o = 0 \dots I_{o\ max}$	±0.02		±0.02		±0.02		±0.02			%/K	

<sup>1</sup> Flexible load distribution: Each output is capable of delivering 75% of  $P_{o\ nom}$  according to table: *Type Survey*. The other output should not exceed the difference to the total output power  $P_{o\ nom}$ .

<sup>2</sup> The current limit is primary side controlled.

<sup>3</sup> Measured with both outputs connected in parallel.

<sup>4</sup> Conditions for specified output. Other output loaded with constant current  $I_o = 0.5 I_{o\ nom}$ .

<sup>5</sup> BW = 20 MHz

<sup>6</sup> Measured with a probe according to EN 61204

<sup>7</sup> The overvoltage protection is not tracking with R/Trim control.

**Thermal Considerations**

If a converter, mounted on a PCB, is located in free, quasi-stationary air (convection cooling) at the indicated maximum ambient temperature  $T_{A\ max}$  (see table: *Temperature specifications*) and is operated at its nominal input voltage and output power, the case temperature  $T_C$  measured at the *Measuring point of case temperature  $T_C$*  (see: *Mechanical Data*) will approach the indicated value  $T_{C\ max}$  after the warm-up phase. However, the relationship between  $T_A$  and  $T_C$  depends heavily on the conditions of operation and integration into a system. The thermal conditions are influenced by input voltage, output current, airflow, temperature of surrounding components and surfaces and the properties of the printed circuit board.  $T_{A\ max}$  is therefore only an indicative value and under practical operating conditions, the ambient temperature  $T_A$  may be higher or lower than this value.

**Caution:** The case temperature  $T_C$  measured at the *Measuring point of case temperature  $T_C$*  (see: *Mechanical Data*) may under no circumstances exceed the specified maximum value. The installer must ensure that under all operating conditions  $T_C$  remains within the limits stated in the table: *Temperature specifications*.

**Overtemperature Protection**

The converters are protected from possible overheating by means of an internal temperature monitoring circuit. It shuts down the unit above the internal temperature limit and attempts to automatically restart every 50 to 60 ms. This feature prevents from excessive internal temperature building up which could occur in heavy overload conditions.

**Connection in Series**

The outputs of one or several single or double output units can be connected in series without any precautions, taking into consideration that the highest output voltage should remain below 42 V to ensure that the output remains SELV.

**Connection in Parallel**

The outputs of one or several double output units (except -0503- types) with equal nominal output voltage can be connected in parallel. Approximate current sharing between 2 or several units is ensured by their load dependent output characteristic.

**Short Circuit Behaviour**

The current limit characteristic shuts down the converter whenever a short circuit is applied to its output. It acts self-protecting and automatically recovers after removal of the overload condition (hiccup mode).

**Output Overvoltage Protection**

The output of single output units as well as -0503- and -05-05- types are protected against overvoltages by a second control loop. In the event of an overvoltage on one of the outputs the unit will shut down and attempt to restart approximately every 50 to 60 ms. Double and dual output units (with exception of the -0503- and -05-05- types) are protected against overvoltages by a Zener diode across the second output. Under worst case conditions the Zener diode will short circuit. Since with double output units both outputs track each other the protection diode is only provided in one of the outputs. The main purpose of this feature is to protect against possible overvoltages which could occur due to a failure in the feedback control circuit. The output overvoltage protection is not designed to withstand externally applied overvoltages.

**Typical Performance Curves**

General conditions :

$T_A = 25^\circ\text{C}$ , unless  $T_C$  is specified. Shut down pin left open circuit. Trim or R input not connected.

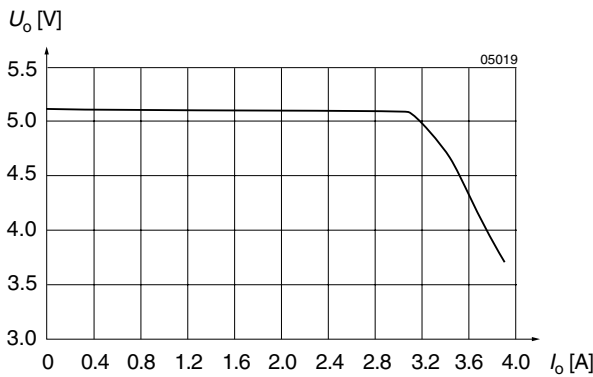

Fig. 8  
 $U_o$  versus  $I_o$  (typ) of units with  $U_o = 5.1$  V.

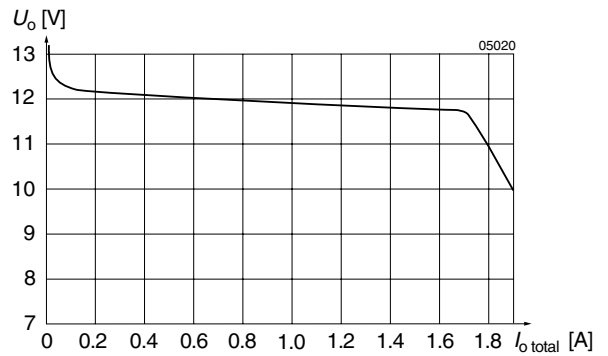

Fig. 9  
 $U_o$  versus  $I_o$  (typ) of double output units ( $2 \times 12$  V), with both outputs in parallel.

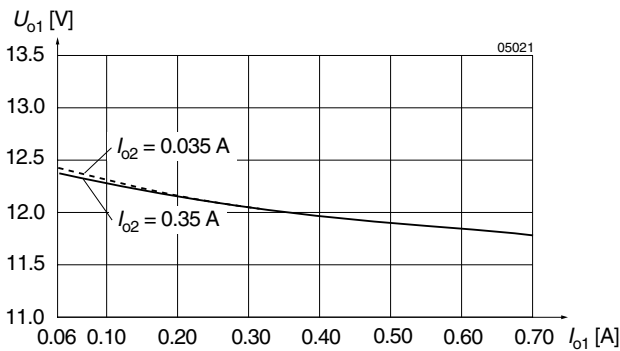

Fig. 10  
 $U_o$  versus  $I_o$  (typ) of double output units with option R ( $2 \times 12$  V), with both outputs in parallel.

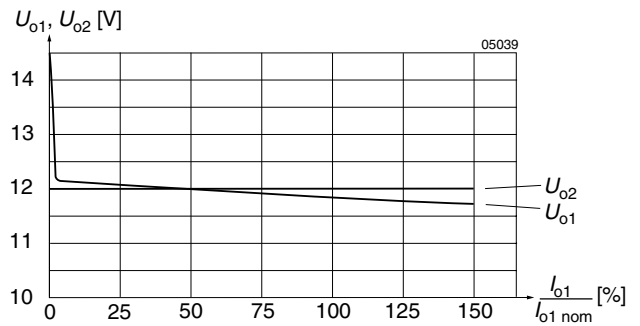

Fig. 11  
Flexible load distribution on double outputs ( $2 \times 12$  V) with load variation from 0...150% of  $P_{o1 \text{ nom}}$  on output 1. Output 2 loaded with 25% of  $P_{o2 \text{ nom}}$ .

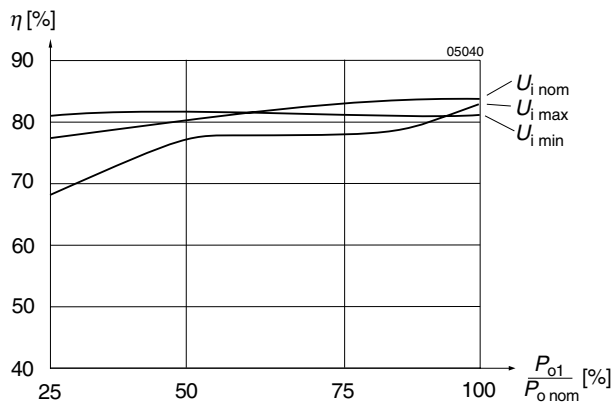

Fig. 12  
Efficiency versus input voltage and load. Typical values (48 IMS 15-12-12-7).

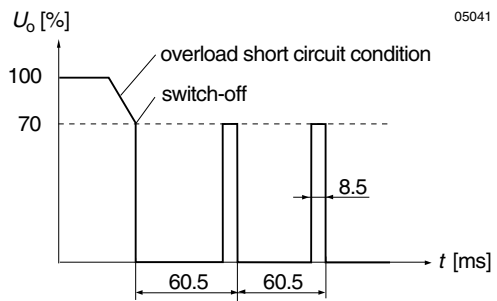

Fig. 13  
Overload switch off (hiccup mode), typical values.

## Auxilliary Functions

### Shut Down Function

The outputs of the converters may be enabled or disabled by means of a logic signal (TTL, CMOS, etc.) applied to the shut down pin. If the shut down function is not required then it should be left open-circuit.

Converter operating: 2.0...20 V  
 Converter shut down: -10...0.7 V

### Adjustable Output Voltage

- R input for single output units and -0503- types
- Trim input for double output units

As a standard feature, the IMS 15 single and double output units offer adjustable output voltage(s) by using the control input R or Trim. If the control input is left open-circuit the output voltage is set to  $U_{o\ nom}$ . For output voltages  $U_o > U_{o\ nom}$ , the minimum input voltage  $U_{i\ min}$  (see: *Electrical Input Data*) increases proportionally to  $U_o/U_{o\ nom}$ .

#### Single output units and -0503- types:

The R input is referenced to the secondary side of the converter. Adjustment of the output voltage is possible by means of either an external resistor or a voltage source.

#### a) Adjustment by means of an external resistor $R_{ext}$ :

Depending upon the value of the required output voltage, the resistor shall be connected

**either:** Between the R pin and  $Vo-$  to achieve an output voltage adjustment range of approximately

$$U_o = 80...100\% U_{o\ nom}$$

$$R_{ext1} \approx 4\ k\Omega \cdot \frac{U_o}{U_{o\ nom} - U_o}$$

**or:** Between the R pin and  $Vo+$  to achieve an output voltage range of approximately  $U_o = 100...105\% U_{o\ nom}$ .

$$R_{ext2} \approx 4\ k\Omega \cdot \frac{(U_o - 2.5V)}{2.5\ V \cdot (U_o/U_{o\ nom} - 1)}$$

#### b) Adjustment by means of an external voltage $U_{ext}$ between $Vo-$ and R pins.

The control voltage range is 1.96...2.62 V and allows for an adjustment in the range of approximately 80...105% of  $U_{o\ nom}$ .

$$U_{ext} \approx \frac{U_o \cdot 2.5\ V}{U_{o\ nom}}$$

Attempting to adjust the output below this range will cause the converter to shut down (hiccup mode).

**Note:** Applying an external control voltage >2.75 V may damage the converter.

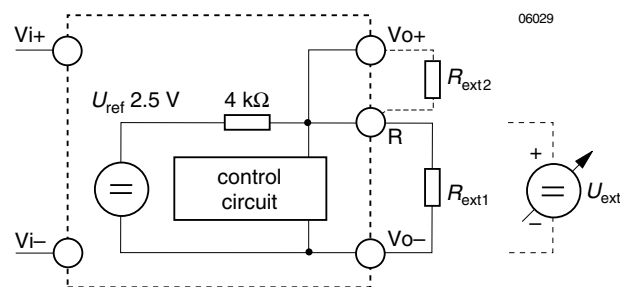

Fig. 14 Output voltage control for single output units and -05-03- types by means of the R input.

### Double output units (except -0503- types):

The Trim input is referenced to the primary side. The figure below shows the circuit topology. Adjustment of the output voltage is possible by means of either an external resistor  $R_{ext}$  in the range of 100...105% of  $U_{o\ nom}$  or an external voltage source in the range of 75...105% of  $U_{o\ nom}$ .

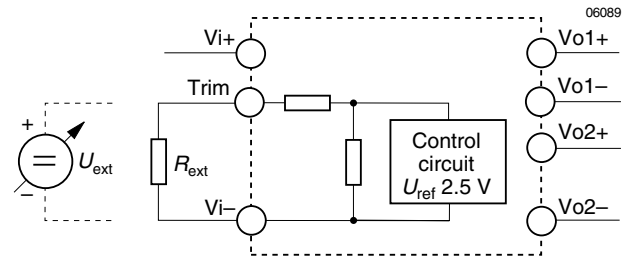

Fig. 15 Output voltage control for double output units by means of the Trim input.

#### a) Adjustment by means of an external resistor $R_{ext}$ :

Programming of the output voltage by means of an external resistor  $R_{ext}$  is possible within a limited range of 100...105% of  $U_{o\ nom}$ .  $R_{ext}$  should be connected between the Trim pin and  $Vi-$ . Connection of  $R_{ext}$  to  $Vi+$  may damage the converter. The following table indicates suitable resistor values for typical output voltages under nominal conditions ( $U_{i\ nom}$ ,  $I_o = 0.5 I_{o\ nom}$ ), with either paralleled outputs or equal load conditions on each outputs.

Table 6:  $R_{ext1}$  for  $U_o > U_{o\ nom}$ ; approximate values ( $U_{i\ nom}$ ,  $I_{o1, 2} = 0.5 I_{o1/2\ nom}$ )

$U_o$ [% $U_{o\ nom}$ ]	$R_{ext}$ [kΩ]
105...108 (107 typically)	0
105	1.5
104	5.6
103	12
102	27
101	68
100	∞

#### b) Adjustment by means of an external voltage source $U_{ext}$ .

For external output voltage programming in the range 75...105% of  $U_{o\ nom}$  a (0...20 V) source  $U_{ext}$  is required, connected to the Trim pin and  $Vi-$ . The table below indicates typical  $U_o$  versus  $U_{ext}$  values under nominal conditions ( $U_{i\ nom}$ ,  $I_o = 0.5 I_{o\ nom}$ ), with either paralleled outputs or equal load conditions on each output. Applying a control voltage >20 V will set the converter into a hiccup mode. Direct paralleling of the Trim pins of units connected in parallel is feasible.

Table 7:  $U_o$  versus  $U_{ext}$  for  $U_o = 75...105\% U_{o\ nom}$ ; typical values ( $U_{i\ nom}$ ,  $I_{o1/2} = 0.5 I_{o1/2\ nom}$ )

$U_o$ [% $U_{o\ nom}$ ]	$U_{ext}$ [V]
≥105	0
102	1.6
95	4.5
85	9
75	13



### Electromagnetic Compatibility (EMC)

A suppressor diode together with an input filter form an effective protection against high input transient voltages

which typically occur in many installations, but especially in battery driven mobile applications.

### Electromagnetic Immunity

Table 8: Immunity type tests

Phenomenon	Standard <sup>1</sup>	Class Level	Coupling mode <sup>2</sup>	Value applied	Waveform	Source Imped.	Test procedure	In oper.	Per- <sup>3</sup> form.
Electrostatic discharge to case	IEC/EN 61000-4-2	2	contact discharge (R pin open)	4000 V <sub>p</sub>	1/50 ns	330 Ω	10 positive and 10 negative discharges	yes	B
		3	air discharge (R pin open)	8000 V <sub>p</sub>					
Electromagnetic field	IEC/EN 61000-4-3	2	antenna	3 V/m	AM 80% 1 kHz		26...1000 MHz	yes	A
	ENV 50204				PM, 50% duty cycle, 200 Hz resp. frequ.		900 MHz		
Electrical fast transient/burst	IEC/EN 61000-4-4	3	direct +i/-i	2000 V <sub>p</sub>	bursts of 5/50 ns 5 kHz rep. rate transients with 15 ms burst duration and a 300 ms period	50 Ω	1 min positive 1 min negative transients per coupling mode	yes	A
Surge	IEC/EN 61000-4-5 <sup>5</sup>	2	+i/-i	1000 V <sub>p</sub>	1.2/50 μs	2 Ω	5 pos. and 5 neg. impulses per coupling mode	yes	B
Conducted disturbances	IEC/EN 61000-4-6	2	+i/-i	3 V <sub>rms</sub> (130 dBμV)	AM modulated 80%, 1 kHz	50 Ω	0.15...80 MHz 150 Ω	yes	A
Transient	ETR 283 (19 Pfl 1) <sup>4</sup>		+i/-i	150 V <sub>p</sub>	0.1/0.3 ms	limited to <100 A	3 positive	yes	B

<sup>1</sup> Related and previous standards are referenced in *Technical Information: Standards*.

<sup>2</sup> i = input, o = output.

<sup>3</sup> A = normal operation, no deviation from specification, B = temporary deviation from specs. possible.

<sup>4</sup> For 48 IMS 15 types (additional external components required). Not applicable for 24 IMS 15 types.

<sup>5</sup> External components required.

### Electromagnetic Emission

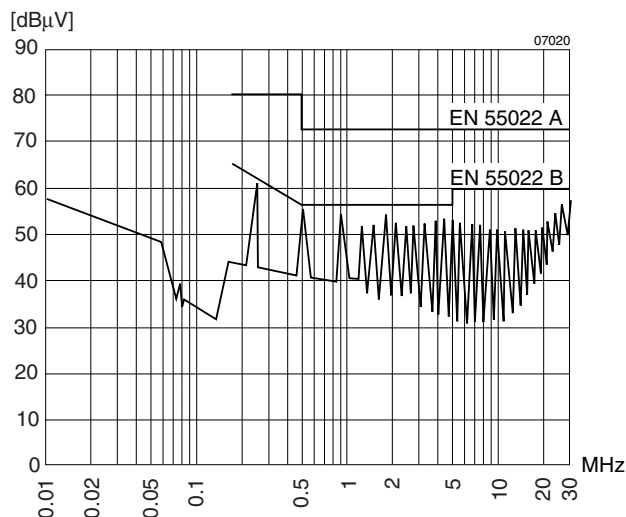

Fig. 16  
Typical disturbance voltage (quasi-peak) at the input according to CISPR 11/EN 55011 and CISPR 22/EN 55022, measured at U<sub>i,nom</sub> and I<sub>o,nom</sub>. Output leads 0.1 m, twisted. (48 IMS 15-05-7R)

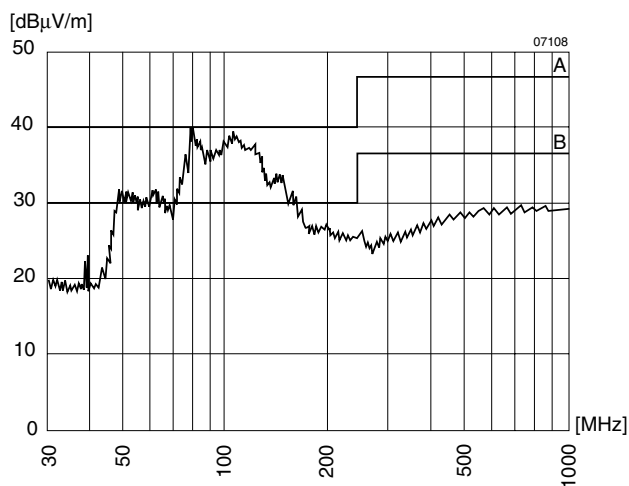

Fig. 17  
Typical radio frequency-interference voltage at U<sub>i,nom</sub>, I<sub>o,nom</sub>, measured with an antenna (distance 10 m). Output leads 1 m, twisted.

**CISPR 22/EN 55022, Level B Radiated**

Electromagnetic emission requirements according to EN 55022, class B (radiated emission) can be achieved by adding an external common mode choke. The filter component should be placed as close as possible to the input of the converter.

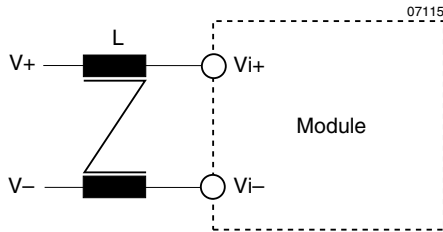

Fig. 18

Example for external circuitry to comply with CISPR22/EN 55022, level B, radiated

Table 9: Input filter components for EN 55022, level B, radiated.

Type	Current compensated choke
24 IMS 15	1 mH, 2A
48 IMS 15	e.g. Tokin, type SC-02-10GS

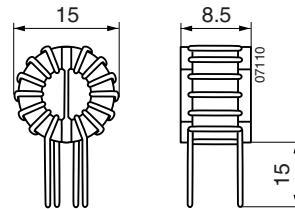

Fig. 19

Choke dimensions

**Immunity to Environmental Conditions**

Table 10: Mechanical stress

Test method		Standard	Test conditions	Status
Ca	Damp heat steady state	IEC/DIN IEC 60068-2-3 MIL-STD-810D section 507.2	Temperature: 40 ±2 °C Relative humidity: 93 +2/-3 % Duration: 56 days	Unit not operating
Ea	Shock (half-sinusoidal)	IEC/EN/DIN EN 60068-2-27 MIL-STD-810D section 516.3	Acceleration amplitude: 50 g <sub>n</sub> = 490 m/s <sup>2</sup> Bump duration: 11 ms Number of bumps: 18 (3 each direction)	Unit operating
Eb	Bump (half-sinusoidal)	IEC/EN/DIN EN 60068-2-29 MIL-STD-810D section 516.3	Acceleration amplitude: 25 g <sub>n</sub> = 245 m/s <sup>2</sup> Bump duration: 11 ms Number of bumps: 6000 (1000 each direction)	Unit operating
Fc	Vibration (sinusoidal)	IEC/EN/DIN EN 60068-2-6 MIL-STD-810D section 514.3	Acceleration amplitude: 0.35 mm (10...60 Hz) 5 g <sub>n</sub> = 49 m/s <sup>2</sup> (60...2000 Hz) Frequency (1 Oct/min): 10...2000 Hz Test duration: 7.5 h (2.5 h each axis)	Unit operating
Kb	Salt mist, cyclic (sodium chloride NaCl solution)	IEC/EN/DIN IEC 60068-2-52	Concentration: 5% (30°C) Duration: 2 h per cycle Storage: 40°C, 93% rel. humidity Storage duration: 22 h per cycle Number of cycles: 3	Unit not operating

Table 11: Temperature specifications, valid for air pressure of 800...1200 hPa (800...1200 mbar)

Temperature		Standard -7		Option -9		Unit	
Characteristics	Conditions	min	max	min	max		
T <sub>A</sub>	Ambient temperature <sup>1</sup>	Operational	-25	71	-40	71	°C
T <sub>C</sub>	Case temperature		-25	95	-40	95	
T <sub>S</sub>	Storage temperature <sup>1</sup>	Non operational	-40	100	-55	100	

<sup>1</sup> MIL-STD-810D section 501.2 and 502.2

**Mechanical Data**

Dimensions in mm. Tolerances ±0.3 mm unless otherwise indicated.

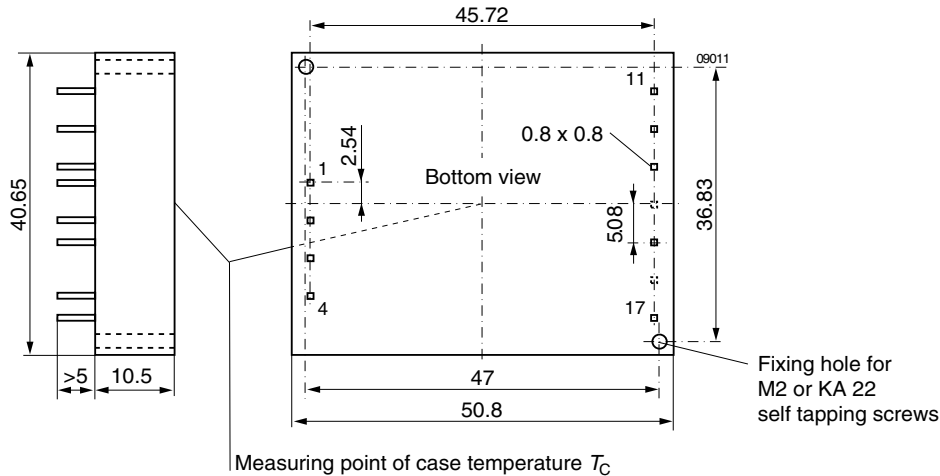
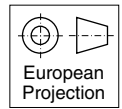

Fig. 20  
Case IMS 15  
Weight: <35 g

**Safety and Installation Instructions**

**Installation Instruction**

Installation of the DC-DC converters must strictly follow the national safety regulations in compliance with the enclosure, mounting, creepage, clearance, casualty, markings and segregation requirements of the end-use application.

Connection to the system shall be made via a printed circuit board with hole diameters of 1.4 mm ±0.1 mm for the pins.

The units should be connected to a secondary circuit.

Check for hazardous voltages before altering any connections.

Do not open the module.

Ensure that a unit failure (e.g. by an internal short-circuit) does not result in a hazardous conditions. See also: *Safety of operator accessible output circuit.*

**Input Fuse**

To prevent excessive current flowing through the input supply line in case of a short-circuit across the converter input an external fuse should be installed in a non earthed input supply line. We recommend a fast acting fuse F3.15A for 24 IMS 15 types and F2A for 48 IMS 15 types.

**Standards and approvals**

All DC-DC converters are pending to be UL recognized according to UL 1950, UL recognized for Canada to CAN/CSA C22.2 No. 950-95 and LGA approved to IEC/EN 60950 standards.

The units have been evaluated for:

- Building in
- Supplementary insulation input to output, based on their maximum input voltage
- The use in a pollution degree 2 environment
- Connecting the input to a secondary circuit which is subject to a maximum transient rating of 1500 V

After approvals the DC-DC converters are subject to manufacturing surveillance in accordance with the above mentioned UL, CSA, EN and ISO 9001 standards.

Table 12: Pin allocation

Pin No.	Single output	-0503-output	Double output	Dual output option K
1	Vi+	Vi+	Vi+	Vi+
2	Vi-	Vi-	Vi-	Vi-
3	-	n.c.	Trim	-
4	$\overline{SD}$	$\overline{SD}$	$\overline{SD}$	$\overline{SD}$
11	-	Vo2+	Vo1+	Vo+
12	-	Go	Vo1-	-
13	Vo+	Vo1+	Vo2+	Go
15	Vo-	Go	Vo2-	Vo-
17	R	R	n.c.	n.c.

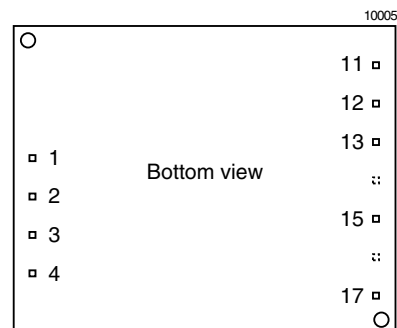

Fig. 21  
Pin allocation

**Protection Degree**

The protection degree of the DC-DC converters is IP 40.

**Cleaning Agents**

In order to avoid possible damage, any penetration of cleaning fluids should be prevented, since the power supplies are not hermetically sealed.

**Isolation**

The electric strength test is performed as factory test in accordance with IEC/EN 60950 and UL 1950 and should not be repeated in the field. Melcher will not honour any guarantee claims resulting from electric strength field tests.

Table 13: Electric strength test voltages

Characteristic	Input to output	Output to output	Unit
Electric strength test voltage 1 s	1.1	0.1	kV <sub>rms</sub>
	1.5	0.15	kV DC
Coupling capacitance	≈2.2	-	nF
Insulation resistance at 500 V DC	>100	-	MΩ
Partial discharge extinction voltage	Consult factory	-	kV

**Safety of Operator Accessible Output Circuit**

If the output circuit of a DC-DC converter is operator accessible, it shall be an SELV circuit according to IEC/EN 60950 related safety standards

The following table shows some possible installation configurations, compliance with which causes the output circuit of the DC-DC converter to be an SELV circuit according to IEC/EN 60950 up to a configured output voltage of 42 V.

However, it is the sole responsibility of the installer to ensure the compliance with the relevant and applicable safety regulations. More information is given in: *Technical Information: Safety*.

Table 14: Insulation concept leading to an SELV output circuit

Conditions	Front end	DC-DC converter	Result		
Supply voltage	Minimum required grade of isolation, to be provided by the AC-DC front end, including mains supplied battery charger	Measures to achieve the specified safety status of the output circuit	Safety status of the DC-DC converter output circuit		
Mains ≤250 V AC	Basic	≤60 V	Earthed SELV circuit <sup>2</sup>	Operational insulation (provided by the DC-DC converter)	SELV circuit
		>60 V	ELV circuit	Input fuse <sup>3</sup> output suppressor diode(s) <sup>4</sup> , and earthed output circuit(s) <sup>2</sup>	Earthed SELV circuit
	Double or reinforced	≤60 V	SELV circuit	Operational insulation (provided by the DC-DC converter)	SELV circuit
		>60 V	TNV-2 circuit Double or reinforced insulated unearthed hazardous voltage secondary circuit <sup>5</sup>	Supplementary insulation, based on the maximum input voltage (provided by the DC-DC converter)	

<sup>1</sup> The front end output voltage should match the specified input voltage range of the DC-DC converter.

<sup>2</sup> The earth connection has to be provided by the installer according to the relevant safety standard, e.g. IEC/EN 60950.

<sup>3</sup> The installer shall provide an approved fuse (type with the lowest rating suitable for the application) in a non-earthed input line directly at the input of the DC-DC converter (see fig.: *Schematic safety concept*). For UL's purpose, the fuse needs to be UL-listed. See also: *Input Fuse*.

<sup>4</sup> Each suppressor diode should be dimensioned in such a way, that in the case of an insulation fault the diode is able to limit the output voltage to SELV (<60 V) until the input fuse blows (see fig.: *Schematic safety concept*).

<sup>5</sup> Has to be insulated from earth by basic insulation according to the relevant safety standard, based on the maximum output voltage from the front end.

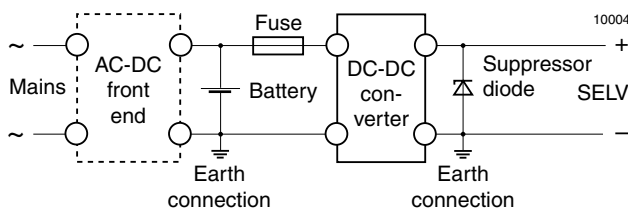

Fig. 22 Schematic safety concept. Use fuse, suppressor diode and earth connection as per table: Safety concept leading to an SELV output circuit.

## Description of Option

### Option -9

Extended ambient temperature range  $-40\dots71\text{ }^{\circ}\text{C}$ .

### Option K

Option K configures the electrically isolated double outputs to the alternative pinout with outputs connected in series ( $V_{o+}/G_{o-}/V_{o-}$ ) and common ground.

However instead of using units with option K, it is recommended to use the standard double output units by providing the printed circuit board with an additional pin hole (for pin 12 of double output units) connected to pin hole 13. This will provide more design-in flexibility since by that both pinouts may be used on the same PCB.

See also fig. *Block diagram, double output units, standard pinout*.

### Option i Inhibit

Excludes shut down and option K.

The output(s) of the converter may be enabled or disabled by means of a logic signal (TTL, CMOS, etc.) applied to the inhibit pin. No output voltage overshoot will occur when the unit is turned on. If the inhibit function is not required the inhibit pin should be connected to  $V_{i-}$  to enable the output (active low logic, fail safe).

Converter operating:  $-10\text{ V}\dots0.8\text{ V}$

Converter inhibited  
or inhibit pin left open:  $2.4\text{ V}\dots U_{i\text{ max}}$

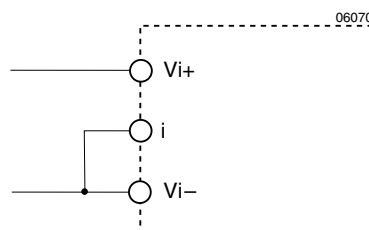

Fig. 23

If the inhibit is not used the inhibit pin should be connected to  $V_{i-}$